

SEACHROME

Seachrome Corporation
1906 East Dominguez Street
Long Beach, California 90810
Phone: (800) 955-2476
Fax: (800) 444-3380

Description:

SSB2-180150 (HW)
18" x 15" BENCH SEAT
with Swing Down Leg

Customer:

Customer Part #

01-07-2013

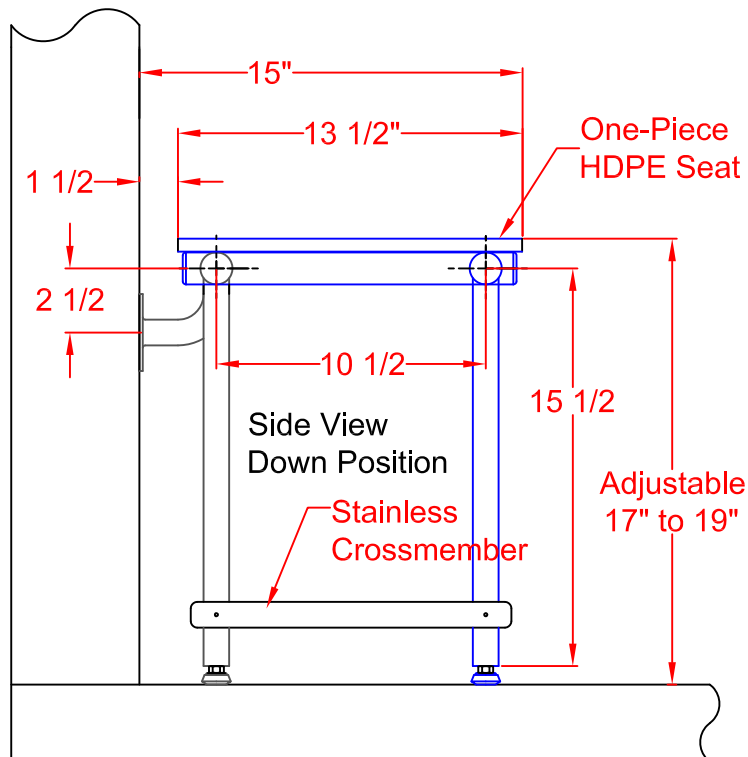
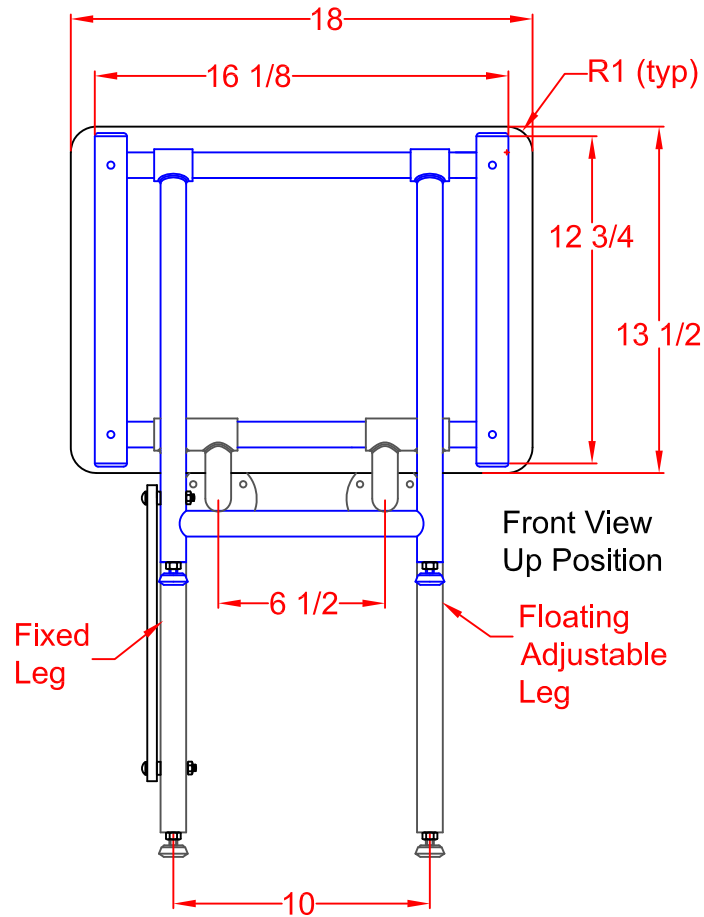

SEACHROME

Seachrome Corporation
1906 East Dominguez Street
Long Beach, California 90810
Phone: (800) 955-2476
Fax: (800) 444-3380

Description:

SSB2-180150 (HW)
18" x 15" BENCH SEAT
with Swing Down Leg

Customer:

Customer Part #

01-07-2013

BENCH SEAT MODEL #SSB2-180150 (HW) with Swing Down Leg (White One-Piece HDPE)

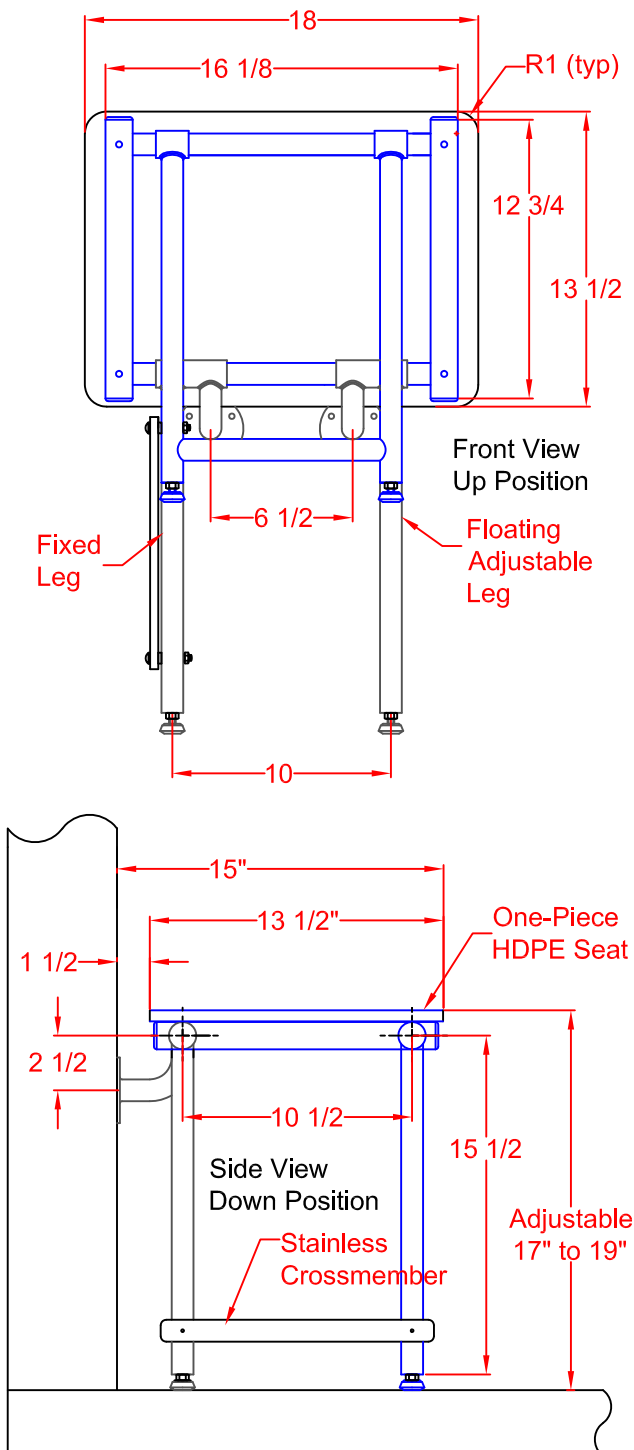

OPERATION:

Seat is automatically held in a raised position by a stainless cross member attached to the front and rear support legs. When the seat is lowered into its down position the Swing Down Leg automatically aligns the front and rear support legs with the help of the stainless cross member.

ARCHITECTURAL SPECIFICATIONS:

Model #SSB2-180150 (HW) Folding Bench Seat from Seachrome Corp., Long Beach, California 90810. Phone: (800) 955-2476.
Frame: Type 304 (18-8) S.S. tube, 1-1/4" (32mm) x 18ga. (1.2mm) sq. main frame with 1" (25mm) x 18ga. (1.2mm) rd. cross members.
Leg: "H"-Shaped yoke of type 304 (18-8) S.S. tubing, 1" (25mm) x 18ga. (1.2mm) rd. tubing, Heliarc welded to 1-1/4" (32mm) rd. x 12ga. (2.7mm) frame hinge.
The swing down legs automatically level when the seat is lowered to a horizontal sitting position. The seat automatically locks itself when swung into its "up" position with the use of the stainless cross member.

MATERIALS:

FRAME: Type 304 (18-8) S.S. tubing, 1-1/4" (32mm) x 18ga. (1.2mm) sq. main frame with 1" (25mm) x 18ga. (1.2mm) rd. cross members.

WALL FLANGES (2): Type 304 (18-8) S.S., 10ga. (3.4mm) x 3" (76mm) Dia. Heliarc welded to 1" (25mm) rd. x 18ga. (1.2mm) 90 degree leg supports, and to 1-1/4" (32mm) rd. x 12ga. (2.7mm) frame hinge couplings. Three mounting holes in each flange.

SWING DOWN LEG: "H" Shaped yoke of type 304 (18-8) S.S. 1" Dia. (25mm) x 18ga. (1.2mm) rd. tubing, heliarc welded to 1-1/4" (32mm) rd. x 12ga. (2.7mm) frame hinge couplings.

SEAT CHOICES: (Designate when ordering)

NW or NA - White (NW) or Almond (NA) Naugahyde covering, 1-1/2" (38mm) foam mounted on 1/2" (13mm) marine plywood.

PW or PT - White (PW) or Teak (PT) Phenolic 1/2" (13mm) x 3" (76mm) slats secured to frame with S.S. screws.

PWS or PTS - White (PW) or Teak (PT) Phenolic 1/2" (13mm) One Piece Solid secured to frame with S.S. screws.

HW - White High Density Polyethylene (HDPE) 1/2" (13mm) thick, secured to frame with S.S. Screws.

SSM - Solid Surface Material 1/2" (13mm) thick, secured to frame with S.S. screws.
(In a variety of colors and patterns).

INSTALLATION:

All Shower Seats must only be installed using suitable fasteners and sufficient in-wall backing materials. A.D.A. mounting height for lowered seat is 17" (432mm) to 19" (482mm).